

Article number: 207321M6812ST  
Description: E+G Shoulder screw  
GN 732.1-M6-8-12-ST

## Measures

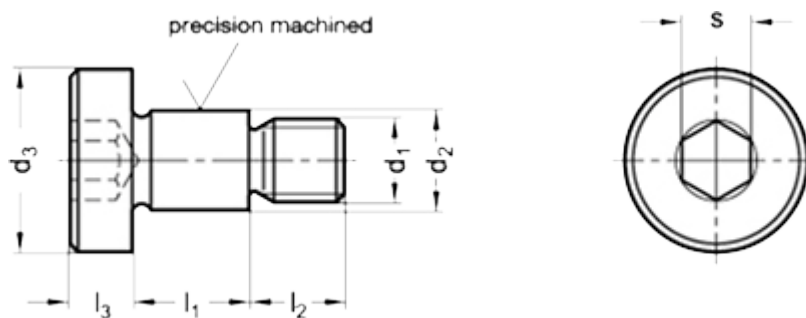

### Application example



d1	= M 6
d2	= 8 -0.05/-0.08
d3	= 14
$l_1 +0.20/+0.13$	= 12
$l_2$	= 8
$l_3$	= 4
s	= 4
Weight in (g)	= 10